

PURDUE
UNIVERSITY
FORT WAYNE

INTERIOR
SIGN STANDARDS
DESIGN INTENT DRAWINGS

PREPARED BY:

corbindesign

109 East Front Street 304
Traverse City, Michigan 49684
www.corbindesign.com
231.947.1236

TABLE OF CONTENTS

Graphic Standards	3
Retrofit Sign Designs	4
Construction Details	4
D-1 Large Building Directory	6
D-2 Small Building Directory	8
D-3 Elevator Directory	10
G-1 Large Wall Guide	12
G-2 Small Wall Guide	14
I-1 Primary Room ID	16
I-2 Primary Room ID w/ Insert	18
I-3 Classroom ID w/ Insert	20
I-4 Office ID w/ Insert	22
I-5 General Room ID	24
I-5a General Room ID w/ Message	26
I-7/a/b Individual Letters	28
O-1 Overhead Flag, Custom	30
O-2 Overhead Flag, Large	32
O-3 Overhead Flag, Small	34
O-4 Overhead Guide	36
O-5 Overhead ID	38
R-1 Regulatory ID	40

Graphic Standards	3
New Construction Sign Designs	5
Construction Details	5
D-1 Large Building Directory	7
D-2 Small Building Directory	9
D-3 Elevator Directory	11
G-1 Large Wall Guide	13
G-2 Small Wall Guide	15
I-1 Primary Room ID	17
I-2 Primary Room ID w/ Insert	19
I-3 Classroom ID w/ Insert	21
I-4 Office ID w/ Insert	23
I-5 General Room ID	25
I-5a General Room ID w/ Message	27
I-7/a/b Individual Letters	29
O-1 Overhead Flag, Custom	31
O-2 Overhead Flag, Large	33
O-3 Overhead Flag, Small	35
O-4 Overhead Guide	37
O-5 Overhead ID	39
O-6 Overhead Flag ID	40
R-1 Regulatory ID	42
R-2 Interior Stair ID	43

WAYFINDING TEAM

Purdue Fort Wayne

Greg Justice
Executive Director of Facilities Management

Craig Campbell
Project Manager

Corbin Design

Clint Douthitt
Lead Designer

Thomas Stevens
Project Manager

Claire Houser
Junior Designer

COLOR PALETTE

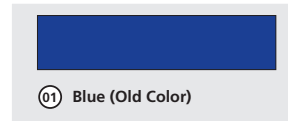

01 Blue (Old Color)

01 Gold

02 Slate

03 Silver Metallic

04 White

05 Black

Pantone®: 110	Cool Gray 11	---	White	Black
Paint: MP70860 R110776 Blue	MP00584	MP18076 Silver Cup Metallic	MP27386	MP00833 Black
Opaque Vinyl: Digitally printed to match Pantone 110	---	---	3M White180mC-10	---

TYPOGRAPHY

Myriad Pro Condensed Italic

Aa Bb Cc Dd Ee Ff Gg Hh Ii Jj Kk Ll Mm Nn Oo Pp Qq Rr Ss Tt Uu Vv Ww Xx Yy Zz 1234567890

Myriad Pro Condensed

Aa Bb Cc Dd Ee Ff Gg Hh Ii Jj Kk Ll Mm Nn Oo Pp Qq Rr Ss Tt Uu Vv Ww Xx Yy Zz 1234567890

Myriad Pro Semibold Condensed

Aa Bb Cc Dd Ee Ff Gg Hh Ii Jj Kk Ll Mm Nn Oo Pp Qq Rr Ss Tt Uu Vv Ww Xx Yy Zz 1234567890

Chaparral Pro Semibold

AA BB CC DD EE FF GG HH II JJ KK LL MM NN OO
PP QQ RR SS TT UU VV WW XX YY ZZ 1234567890

Helvetica Neue 67 Medium Condensed

Aa Bb Cc Dd Ee Ff Gg Hh Ii Jj Kk Ll Mm Nn Oo Pp Qq Rr Ss Tt Uu Vv Ww Xx Yy Zz
1234567890

Helvetica Neue 77 Bold Condensed

Aa Bb Cc Dd Ee Ff Gg Hh Ii Jj Kk Ll Mm Nn Oo Pp Qq Rr Ss Tt Uu Vv Ww Xx Yy Zz
1234567890

Minion Pro Bold

AA BB CC DD EE FF GG HH II JJ KK LL MM NN OO
PP QQ RR SS TT UU VV WW XX YY ZZ 1234567890

OLD TYPOGRAPHY STANDARDS

Symbol Standards



Standard Arrow



[RUH]
Restrooms, Unisex
Handicap Accessible



[RMH]
Restroom, Men
Handicap Accessible



[RWH]
Restroom, Women
Handicap Accessible



[RFH]
Restroom, Family
Handicap Accessible



[E]
Elevator



[S]
Stairs



[H]
Handicap Accessible



[F]
Food Court



[MOM]
Mother's Room



[P-1, 2, 3]
Parking Garage 1, 2, 3



Logos

PURDUE
UNIVERSITY
FORT WAYNE

Purdue University
Fort Wayne
Identity



Purdue University
Fort Wayne
Athletic Identity
(Under Development)



Indiana University Purdue University
Fort Wayne Identity
(Old Logo)



Indiana University Purdue University
Fort Wayne Athletic Identity
(Old Logo)

Wayfinding

Graphic Standards

Color, Typography,
Symbol Standards

Notes

Fabricator is responsible for matching all colors and materials as specified and are required to provide color and material samples to Corbin for approval.

CAUTION! CONSISTENT AND ACCURATE COLOR REPRODUCTION IN THIS DOCUMENT CANNOT BE ASSURED DUE TO THE LIMITATIONS OF COLOR COPYING TECHNOLOGY.

The Coated Pantone Matching System®, Matthews and/or Akzo Nobel Paint system is used for specifying signage color matches. (In the absence of actual sign material color chip reference sets, actual specified product color swatches should be referenced for color matching.)

Shown here are approximations of the primary signage background colors and supporting accent colors. Actual color finishes on signage must be matte or low luster (not shiny or glossy unless otherwise noted) and exclusively a premium acrylic polyurethane.

Signage paints produced by MPC Matthews Paint and Akzo Nobel Paint Company are to be the standard reference.

Vinyl Films from 3M and Avery Graphics are to be the standard.

Color application varies per sign type. Refer to drawings for appropriate application.

Client

PURDUE
UNIVERSITY
FORT WAYNE

>
corbindesign

109 East Front Suite 304
Traverse City, MI 49684
231 947.1236

**Construction Detail
(window inserts)**

Color

- ① Gold
- ② Slate
- ③ Silver Metallic
- ④ White
- ⑤ Black

Scale

1" = 1" (on an 11" x 17" sheet)

Notes

This drawing is design-intent only. Fabricator is responsible for fabrication and overall level of quality. Any changes in design, materials, fabrication method or other details must be approved by Corbin Design and PFW.

Client

PURDUE
UNIVERSITY
FORT WAYNE

>
corbindesign

109 East Front Suite 304
Traverse City, MI 49684
231 947.1236

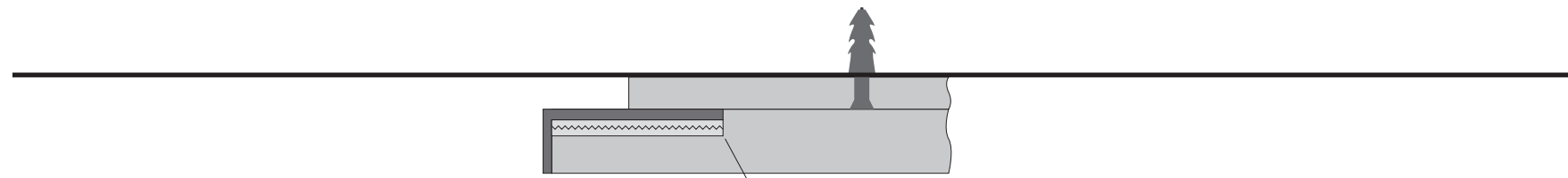

Top View

Rabbit-cut acrylic header with 3M Dual Lock

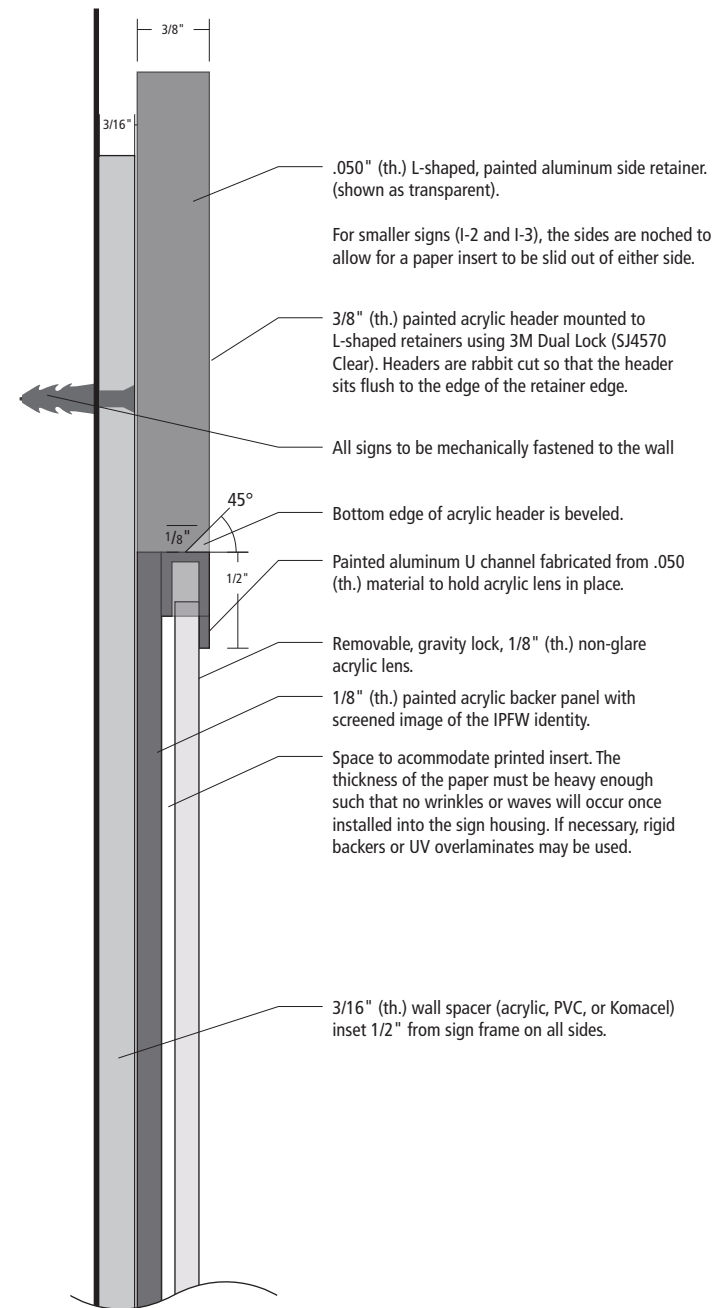

Side View

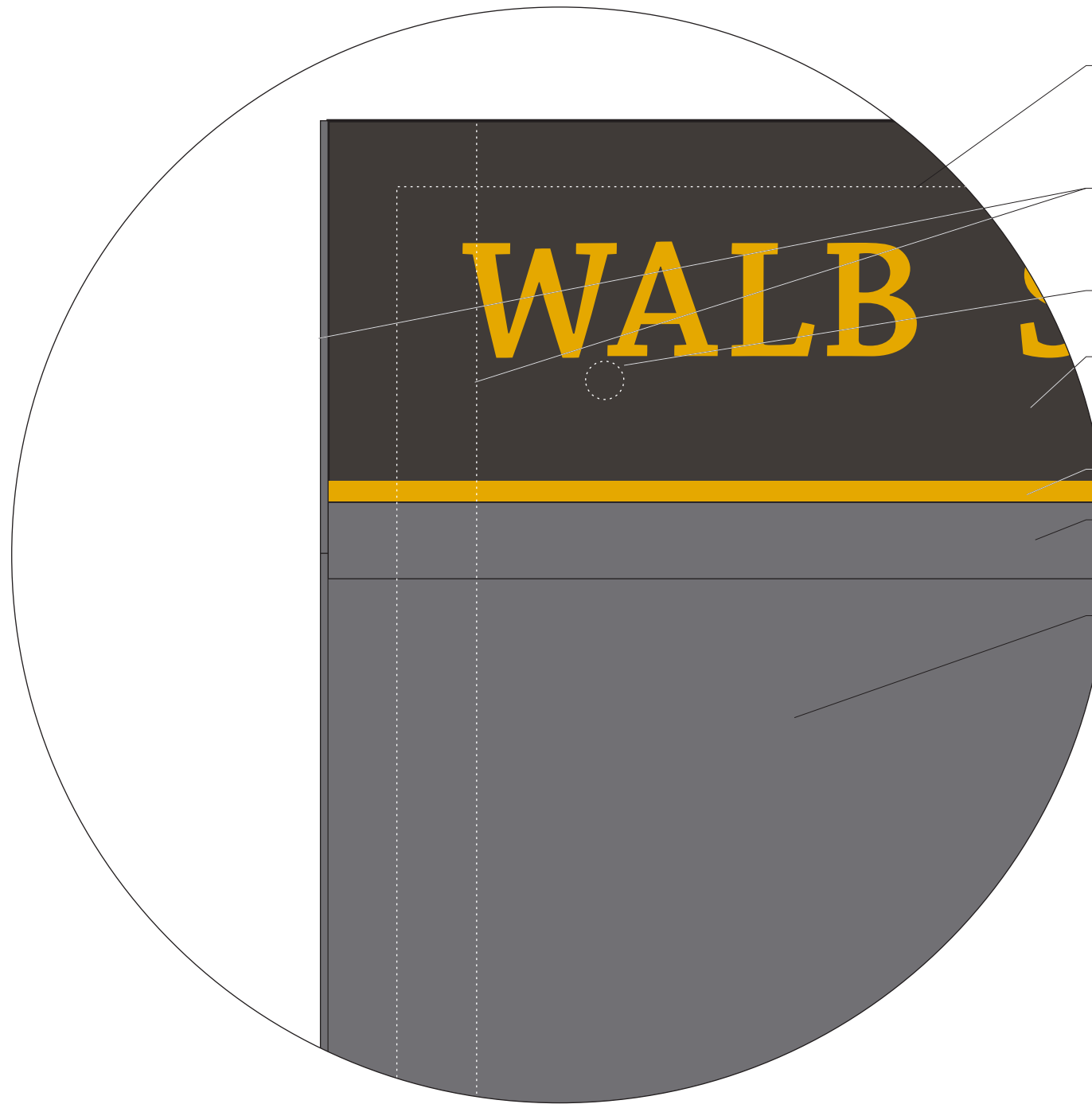

Front View Detail

Dotted line represents blue acrylic backer, inset 1/2" from edge.

.050" (th.) painted aluminum side L retainer. Dotted line represents L retainer behind panels.

Mechanical fastener behind acrylic panel.

3/8" (th.) painted acrylic header. mounted to L-shaped retainers using 3M Dual Lock (SJ4570 Clear). Headers are rabbit cut so that the header sits flush to the edge of the

Bottom edge of acrylic header is beveled. and painted gold

Painted aluminum U channel fabricated from .050 (th.) material to hold acrylic lens in place.

See detail to left for acrylic lens, insert and backer panel fabrication.

.050" (th.) L-shaped, painted aluminum side retainer. (shown as transparent).

For smaller signs (I-2 and I-3), the sides are notched to allow for a paper insert to be slid out of either side.

3/8" (th.) painted acrylic header mounted to L-shaped retainers using 3M Dual Lock (SJ4570 Clear). Headers are rabbit cut so that the header sits flush to the edge of the retainer edge.

All signs to be mechanically fastened to the wall

Bottom edge of acrylic header is beveled.

Painted aluminum U channel fabricated from .050 (th.) material to hold acrylic lens in place.

Removable, gravity lock, 1/8" (th.) non-glare acrylic lens.

1/8" (th.) painted acrylic backer panel with screened image of the IPFW identity.

Space to accommodate printed insert. The thickness of the paper must be heavy enough such that no wrinkles or waves will occur once installed into the sign housing. If necessary, rigid backers or UV overlaminates may be used.

3/16" (th.) wall spacer (acrylic, PVC, or Komacel) inset 1/2" from sign frame on all sides.

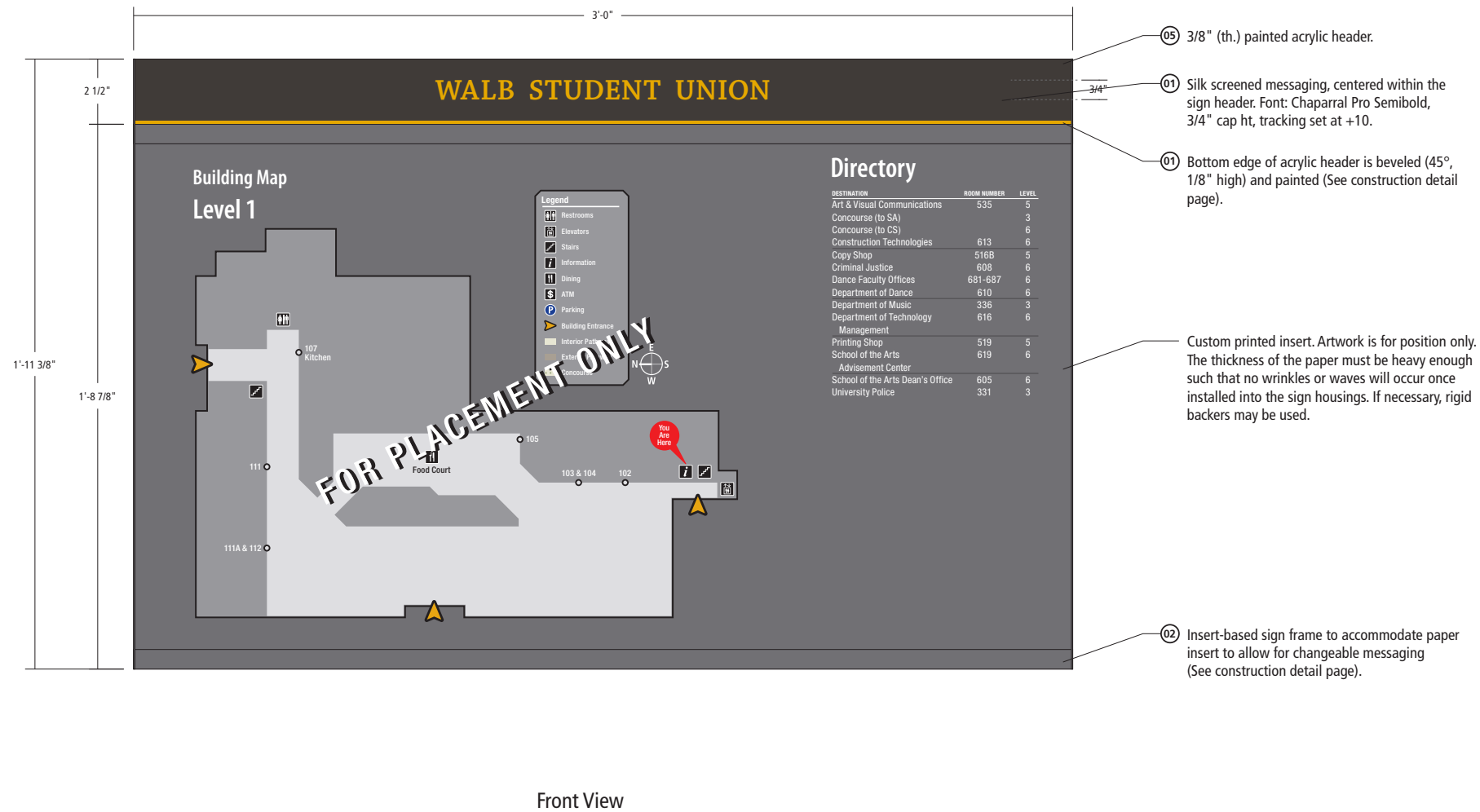
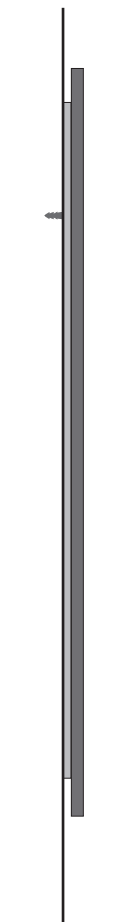
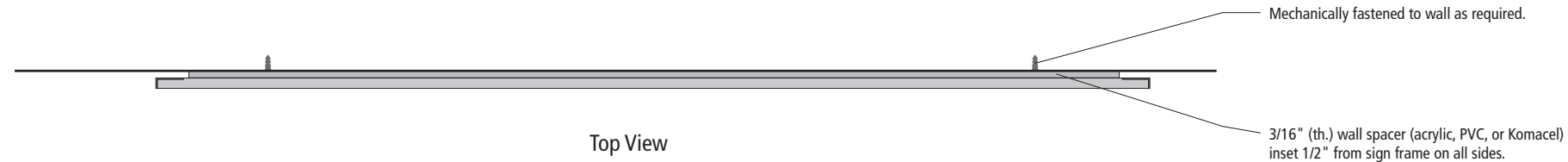

Exterior Design

D-1
Large Building Directory

Color

- 01 Gold
- 02 Slate
- 03 Silver Metallic
- 04 White
- 05 Black

Scale

2" = 1' - 0" (on an 11" x 17" sheet)

Notes

This drawing is design-intent only. Fabricator is responsible for fabrication and overall level of quality. Any changes in design, materials, fabrication method or other details must be approved by Corbin Design and PFW.

Client



109 East Front Suite 304
Traverse City, MI 49684
231 947.1236

D-2
Small Building Directory

Color

- 01 Gold
- 02 Slate
- 03 Silver Metallic
- 04 White
- 05 Black

Scale

2" = 1' - 0" (on an 11" x 17" sheet)

Notes

This drawing is design-intent only. Fabricator is responsible for fabrication and overall level of quality. Any changes in design, materials, fabrication method or other details must be approved by Corbin Design and PFW.

Client



109 East Front Suite 304
Traverse City, MI 49684
231 947.1236

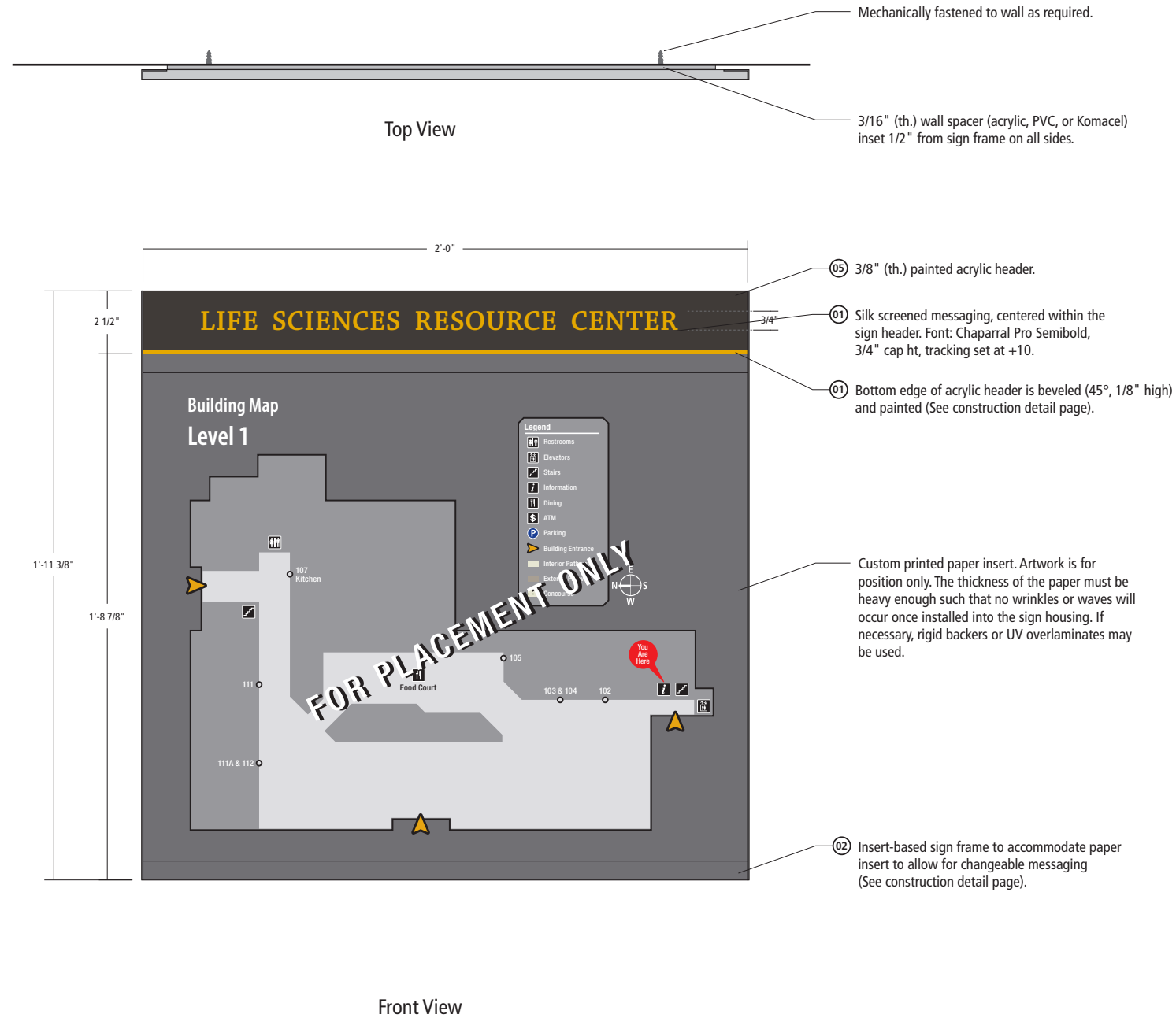

D-3
Elevator Directory

Color

- 01 Gold
- 02 Slate
- 03 Silver Metallic
- 04 White
- 05 Black

Scale

2" = 1' - 0" (on an 11" x 17" sheet)

Notes

This drawing is design-intent only. Fabricator is responsible for fabrication and overall level of quality. Any changes in design, materials, fabrication method or other details must be approved by Corbin Design and PFW.

Client

PURDUE
UNIVERSITY
FORT WAYNE

>
corbindesign

109 East Front Suite 304
Traverse City, MI 49684
231 947.1236

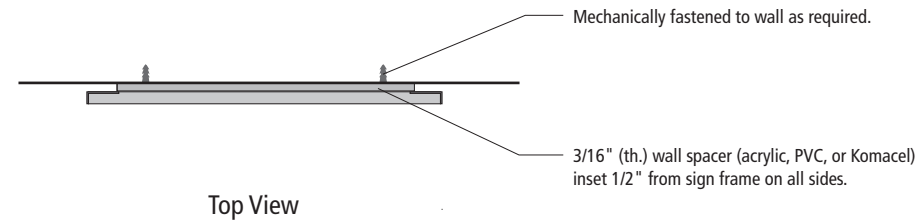

Top View

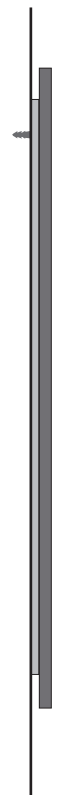

Side View

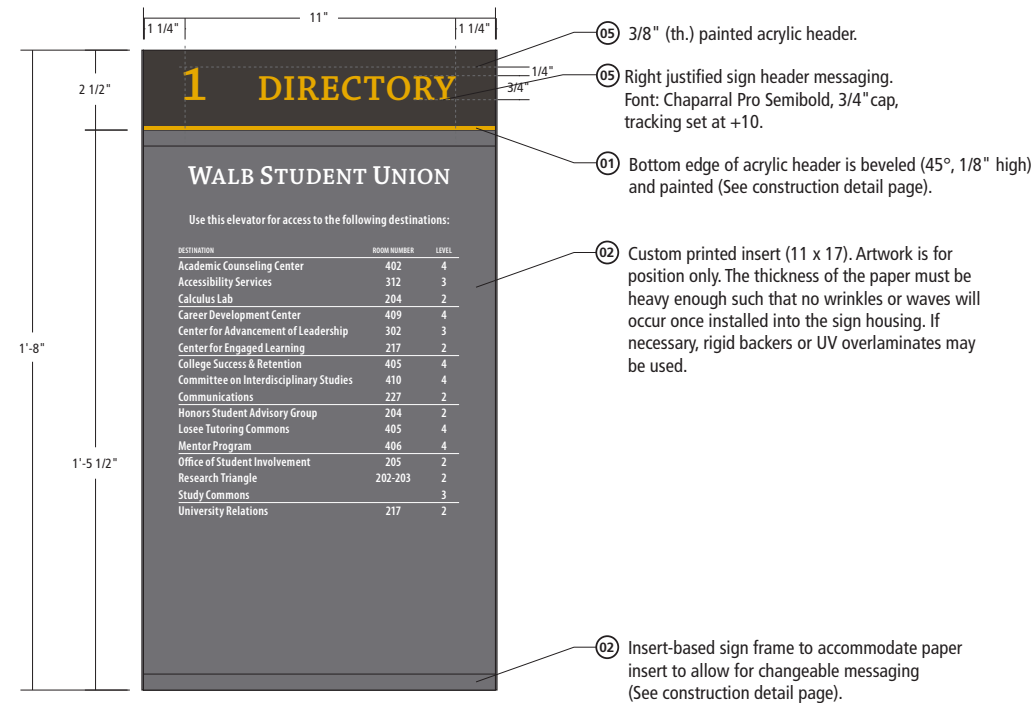

Front View

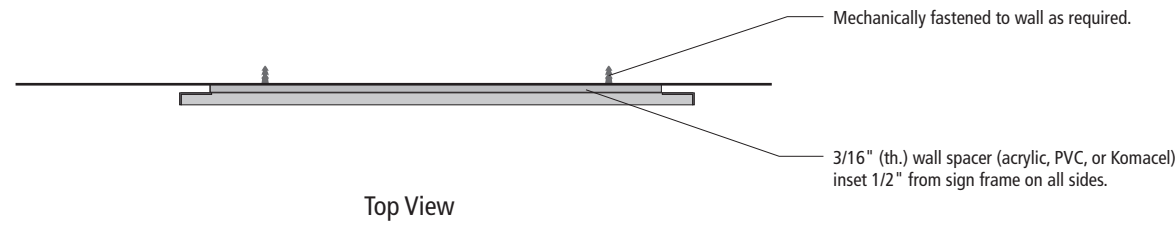

Top View

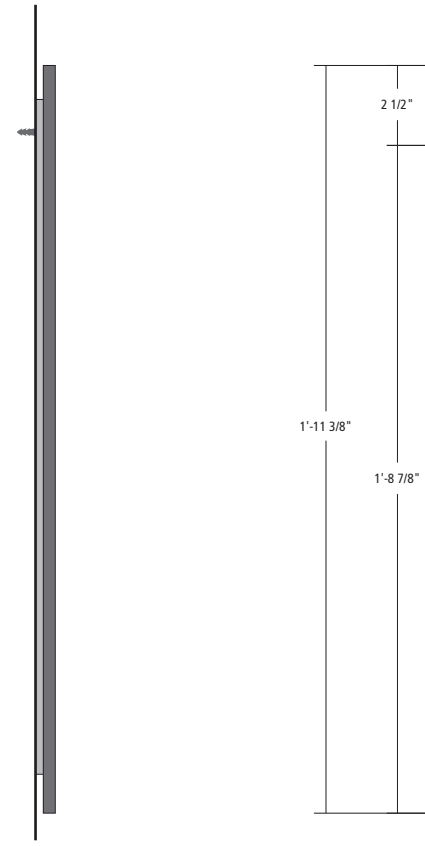

Side View

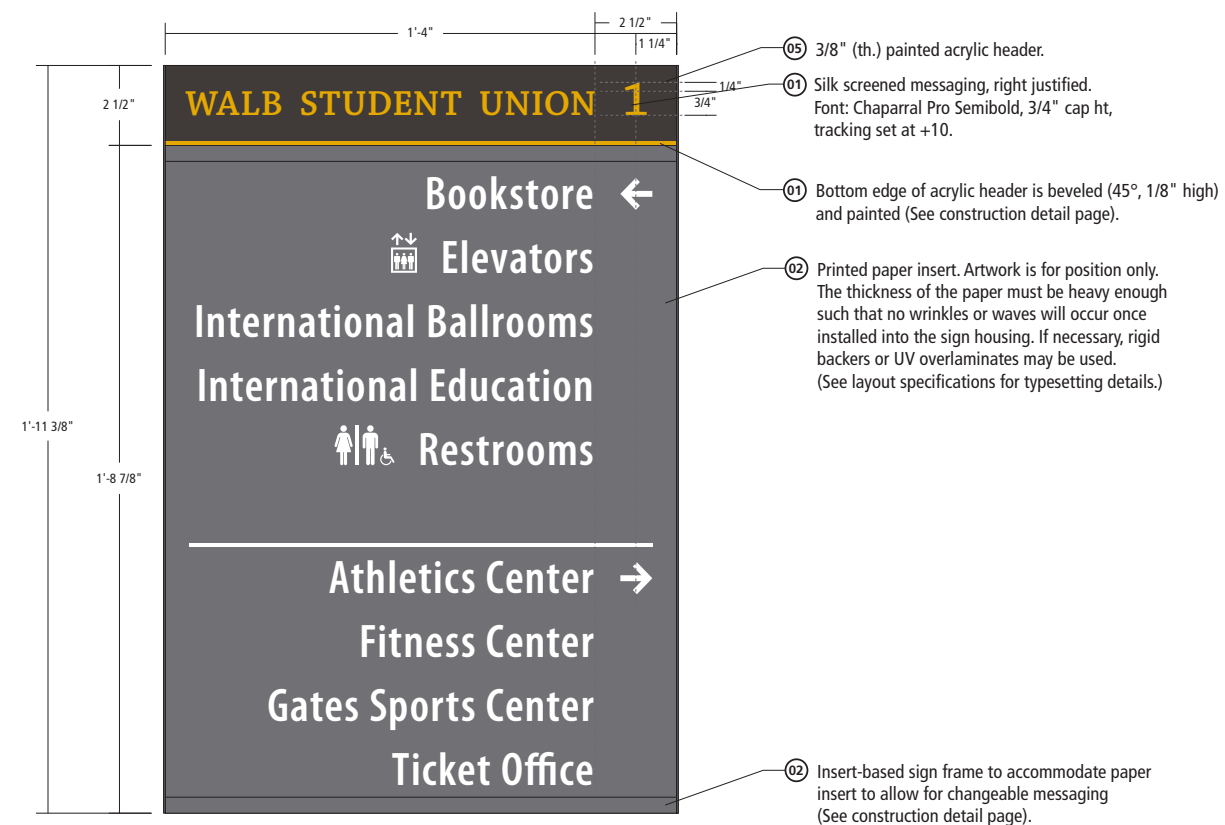

Front View

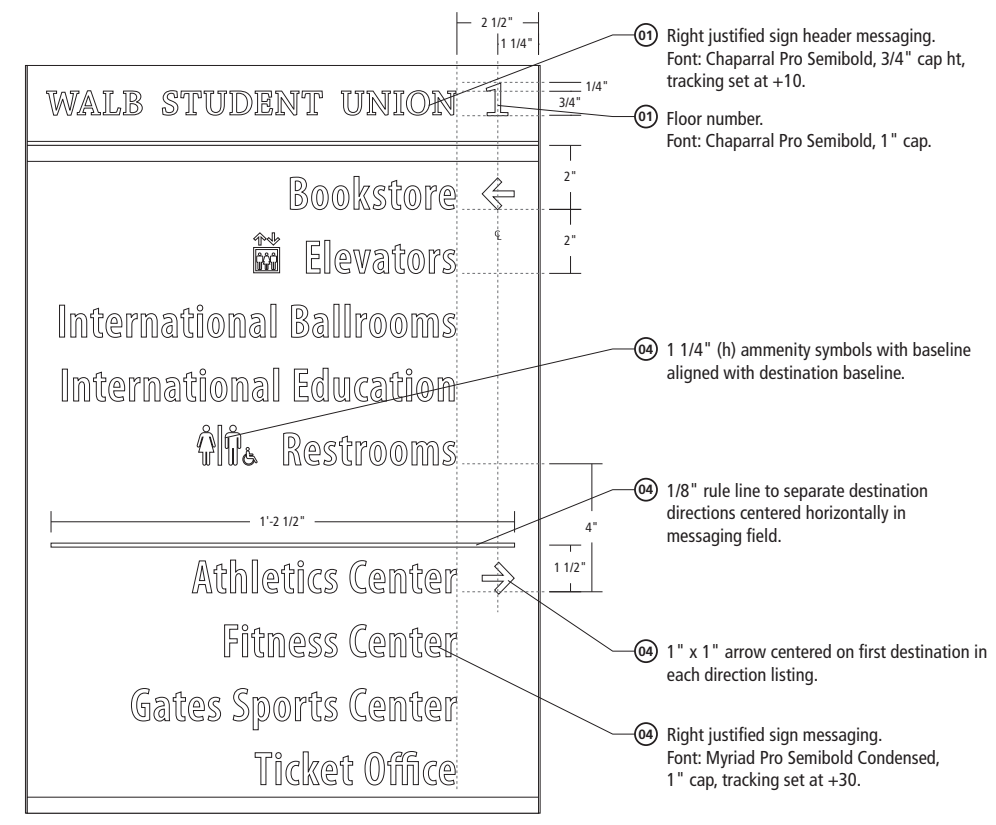

Layout Specifications

Exterior Design

G-1
Large Wall Guide

Color

- 01 Gold
- 02 Slate
- 03 Silver Metallic
- 04 White
- 05 Black

Scale

2" = 1' - 0" (on an 11" x 17" sheet)

Notes

This drawing is design-intent only. Fabricator is responsible for fabrication and overall level of quality. Any changes in design, materials, fabrication method or other details must be approved by Corbin Design and PFW.

Client

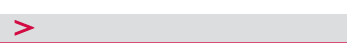

corbindesign

109 East Front Suite 304
Traverse City, MI 49684
231 947.1236

G-2
Small Wall Guide

Color

- 01 Gold
- 02 Slate
- 03 Silver Metallic
- 04 White
- 05 Black

Scale

2" = 1' - 0" (on an 11" x 17" sheet)

Notes

This drawing is design-intent only. Fabricator is responsible for fabrication and overall level of quality. Any changes in design, materials, fabrication method or other details must be approved by Corbin Design and PFW.

Client

PURDUE
UNIVERSITY
FORT WAYNE

>
corbindesign

109 East Front Suite 304
Traverse City, MI 49684
231 947.1236

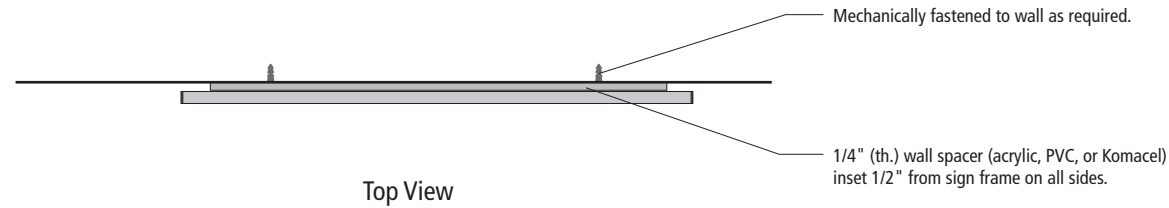

Top View

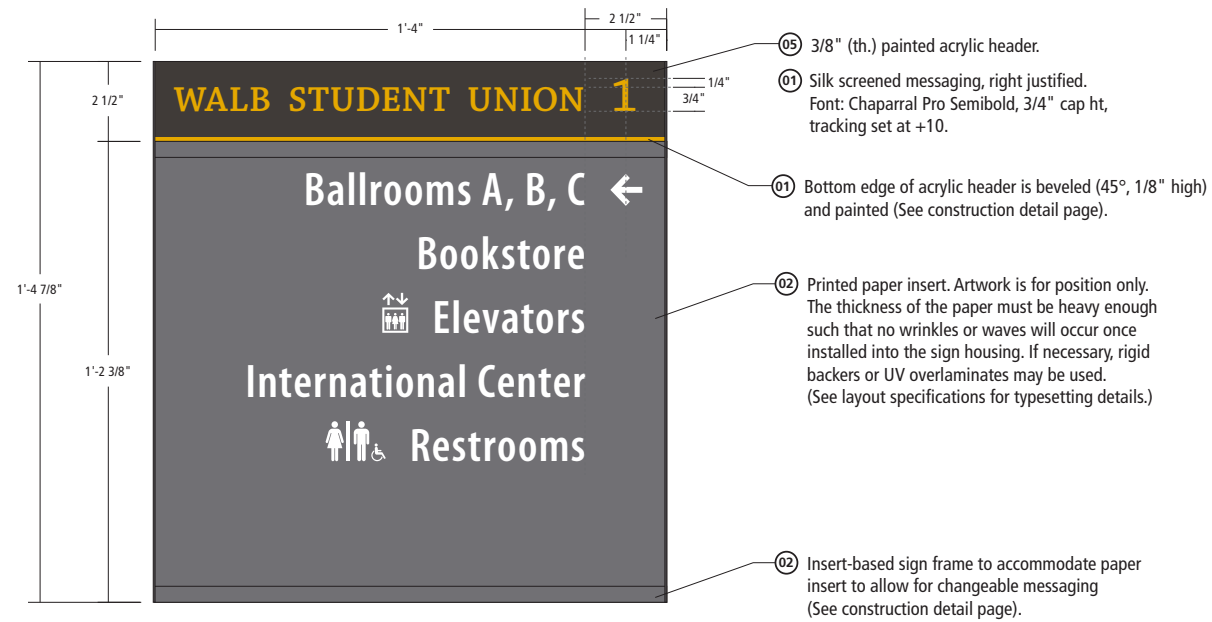

Front View

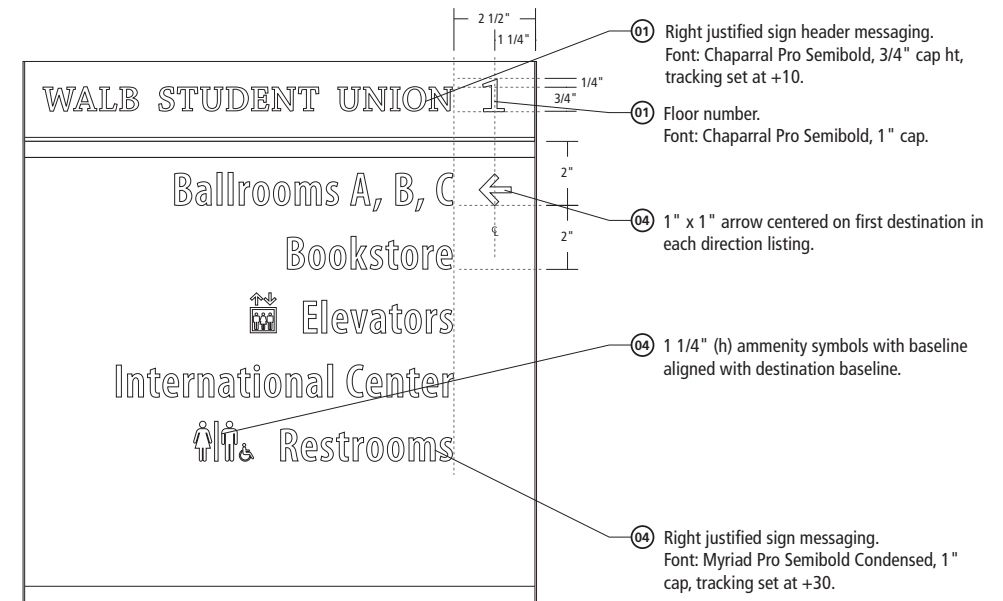

Layout Specifications



Side View

I-1
Primary Room ID

Color

- 01 Gold
- 02 Slate
- 03 Silver Metallic
- 04 White
- 05 Black

Scale

2" = 1' - 0" (on an 11" x 17" sheet)

Notes

This drawing is design-intent only. Fabricator is responsible for fabrication and overall level of quality. Any changes in design, materials, fabrication method or other details must be approved by Corbin Design and PFW.

Client



109 East Front Suite 304
Traverse City, MI 49684
231 947.1236

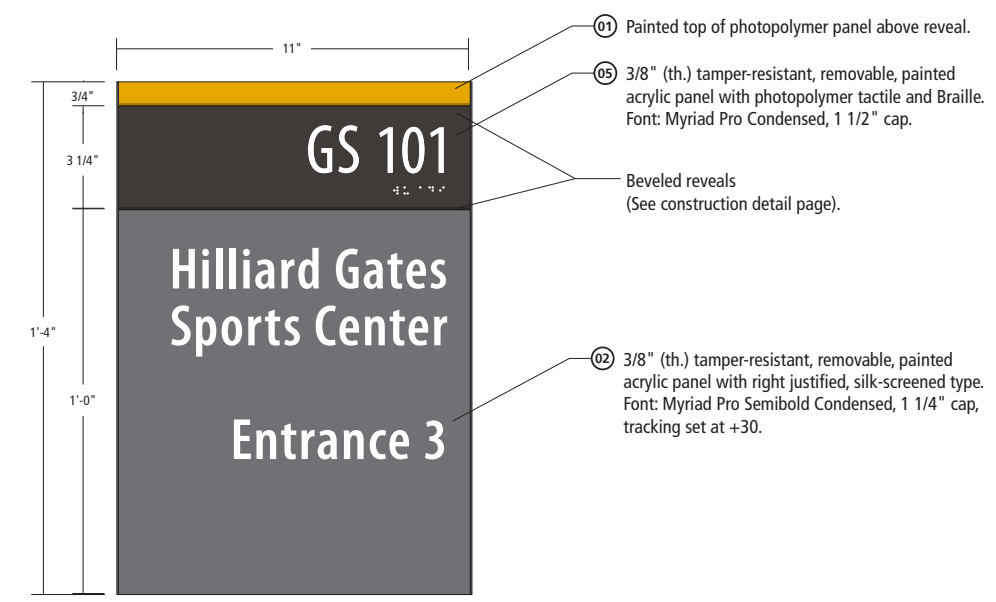
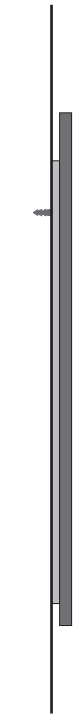
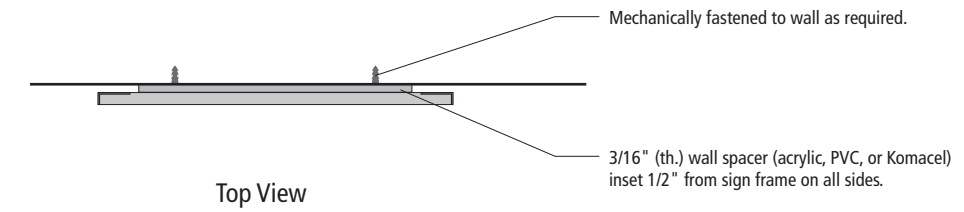

Front View

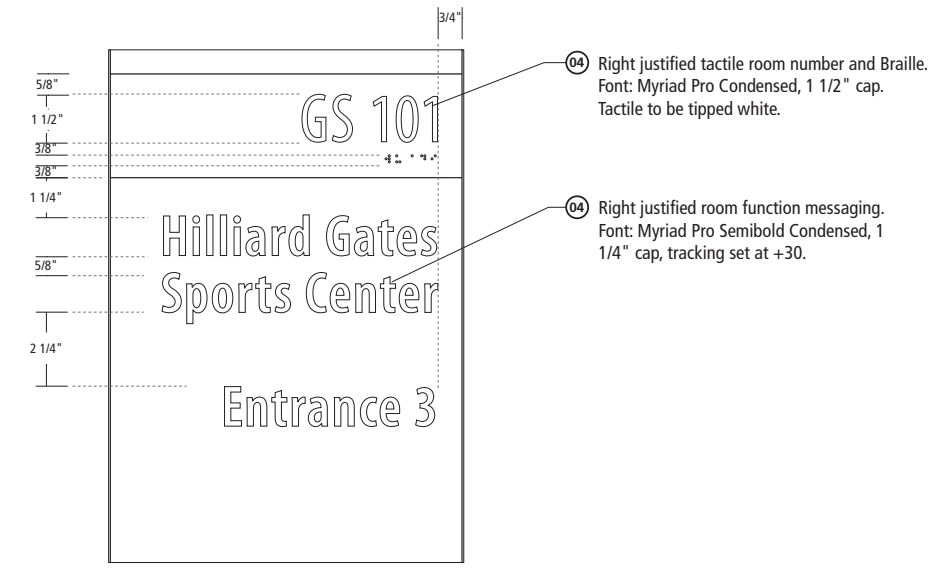

Layout Specifications

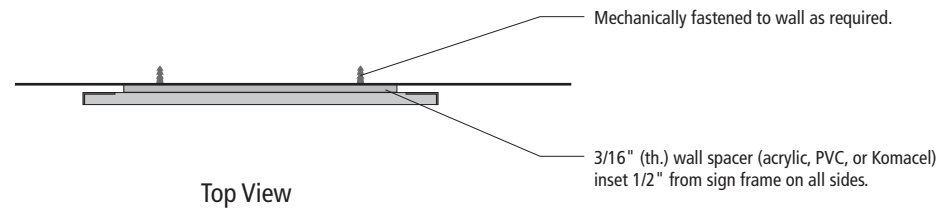

Top View

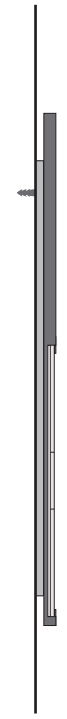

Side View

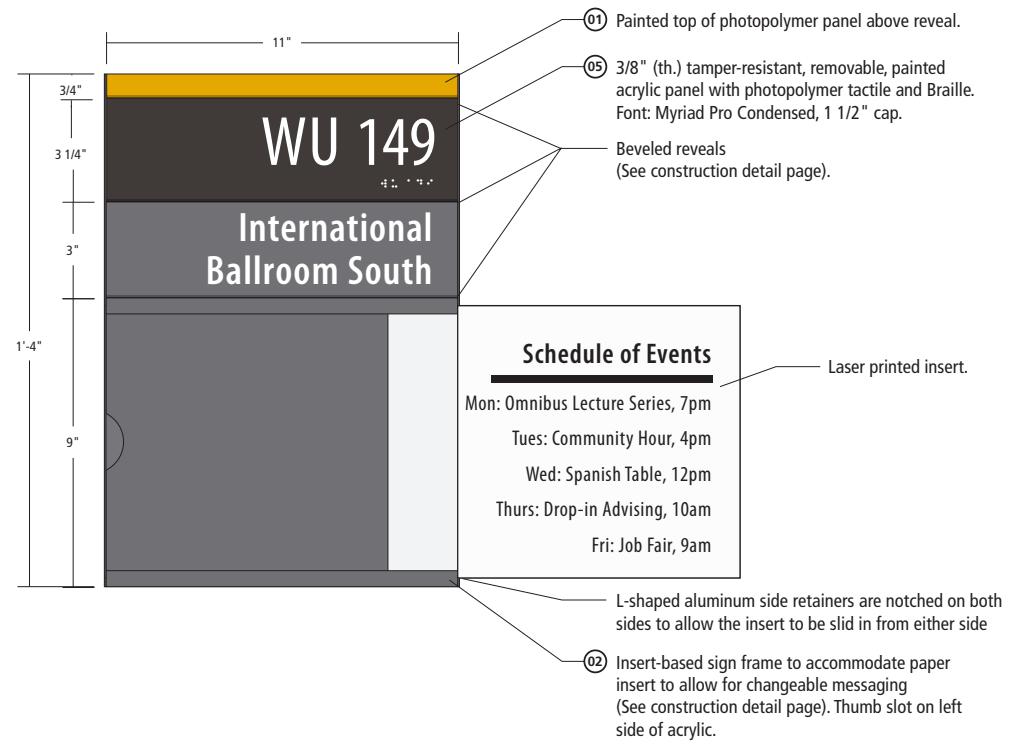

Front View

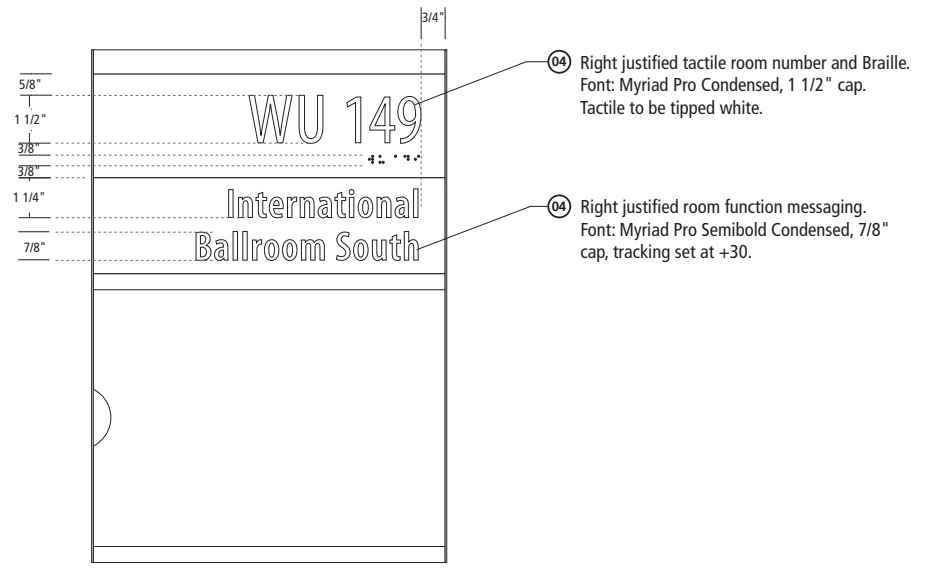

Layout Specifications

Exterior Design

I-2
Primary Room ID w/Insert

Color

- 01 Gold
- 02 Slate
- 03 Silver Metallic
- 04 White
- 05 Black

Scale

2" = 1' - 0" (on an 11" x 17" sheet)

Notes

This drawing is design-intent only. Fabricator is responsible for fabrication and overall level of quality. Any changes in design, materials, fabrication method or other details must be approved by Corbin Design and PFW.

Client



109 East Front Suite 304
Traverse City, MI 49684
231 947.1236

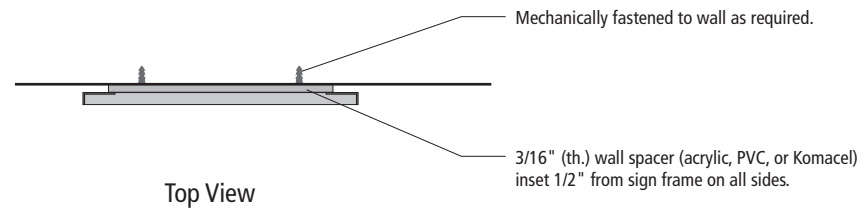

Top View

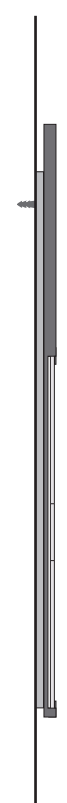

Side View

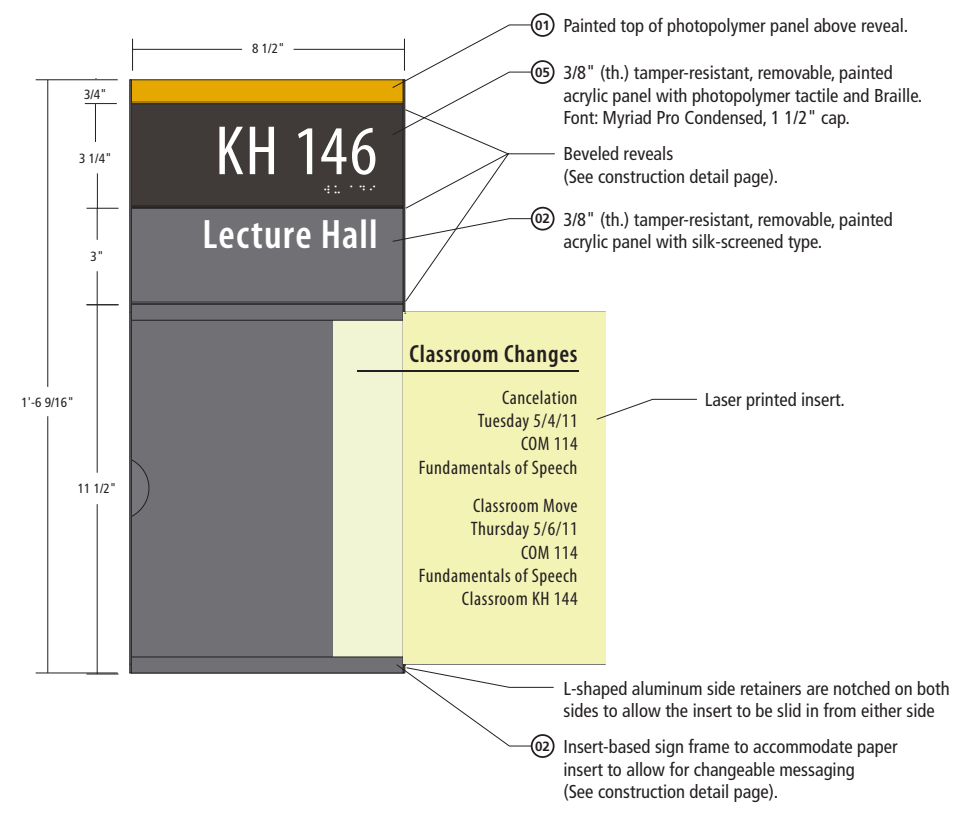

Front View

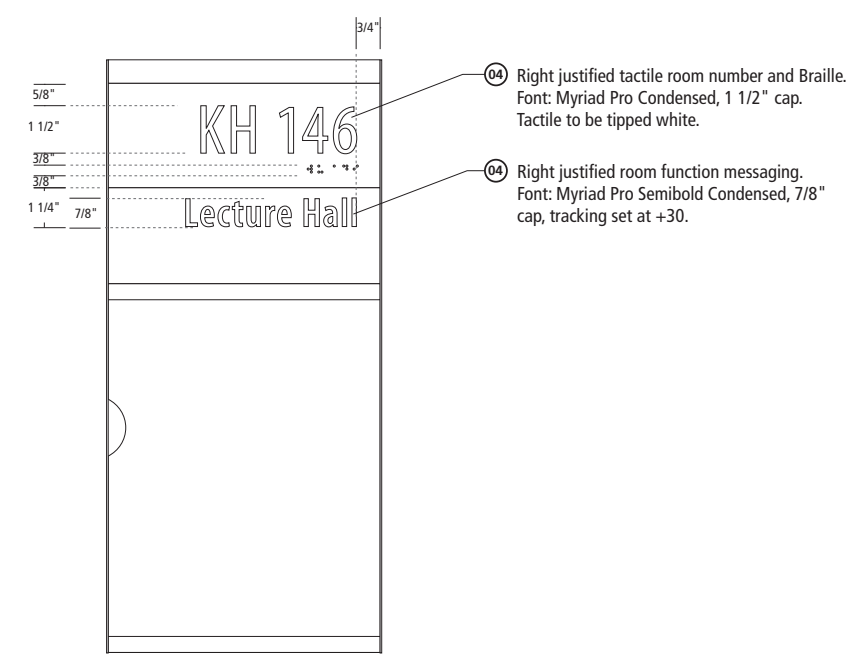

Layout Specifications

Exterior Design

I-3
Classroom ID w/Insert

Color

- 01 Gold
- 02 Slate
- 03 Silver Metallic
- 04 White
- 05 Black

Scale

2" = 1' - 0" (on an 11" x 17" sheet)

Notes

This drawing is design-intent only. Fabricator is responsible for fabrication and overall level of quality. Any changes in design, materials, fabrication method or other details must be approved by Corbin Design and PFW.

Client



109 East Front Suite 304
Traverse City, MI 49684
231 947.1236

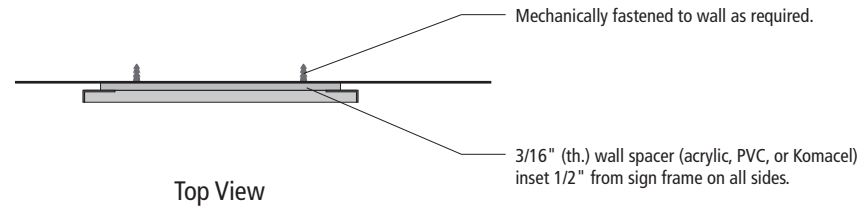

Top View

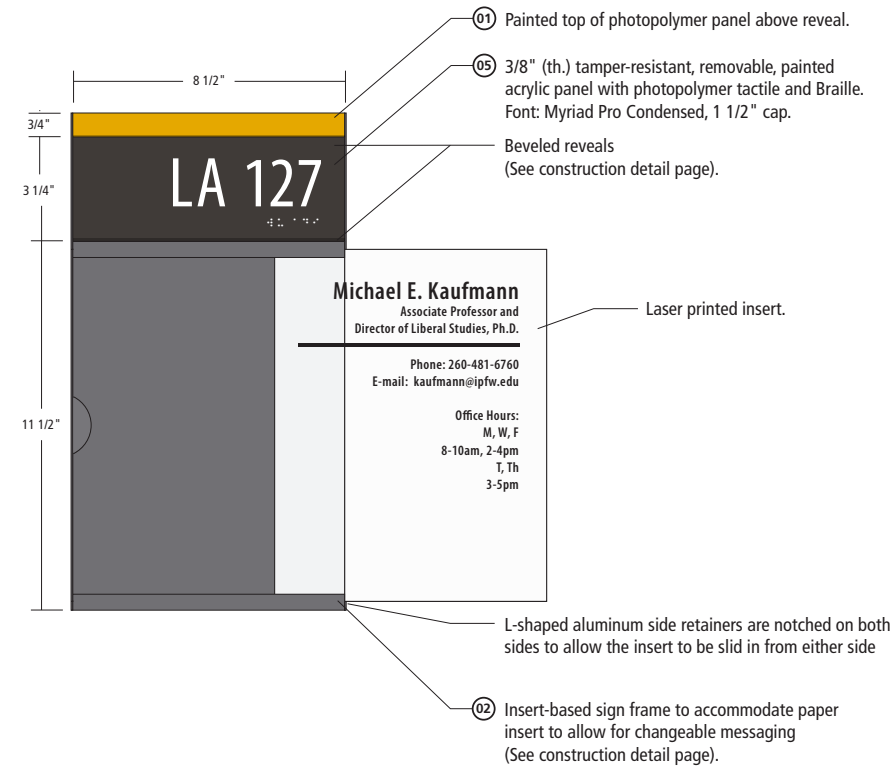

Front View

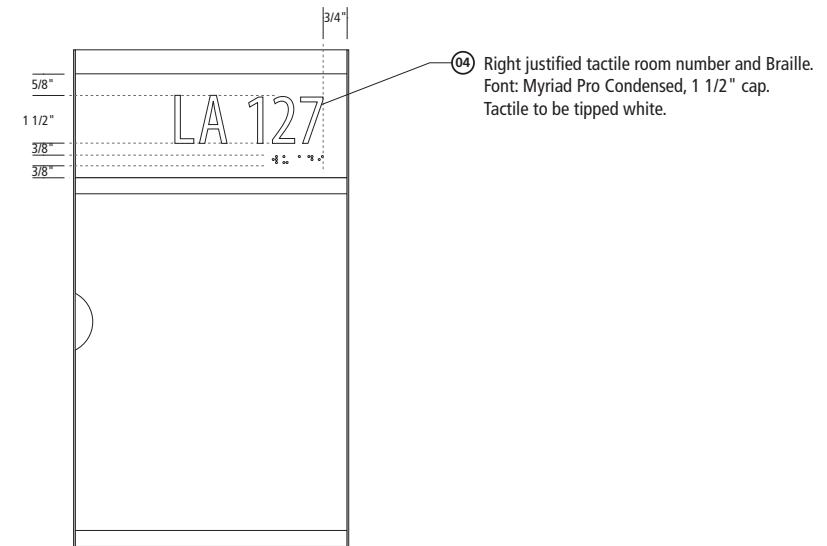

Layout Specifications



Side View

Exterior Design

I-4
Office ID w/Insert

Color

- 01 Gold
- 02 Slate
- 03 Silver Metallic
- 04 White
- 05 Black

Scale

2" = 1' - 0" (on an 11" x 17" sheet)

Notes

This drawing is design-intent only. Fabricator is responsible for fabrication and overall level of quality. Any changes in design, materials, fabrication method or other details must be approved by Corbin Design and PFW.

Client

PURDUE
UNIVERSITY
FORT WAYNE

>
corbindesign

109 East Front Suite 304
Traverse City, MI 49684
231 947.1236

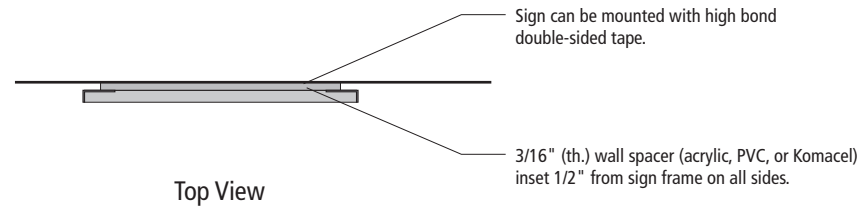

Top View

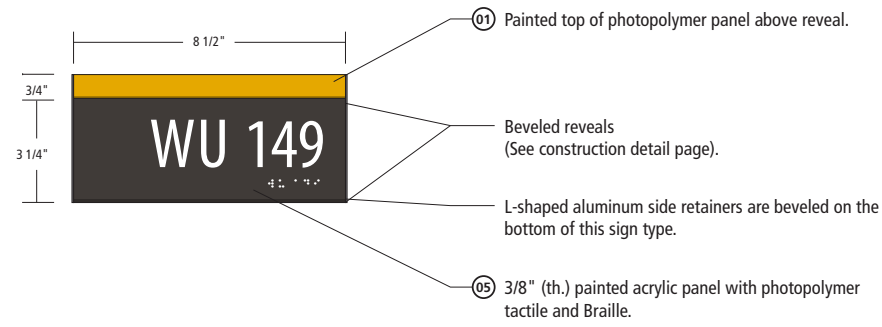

Front View

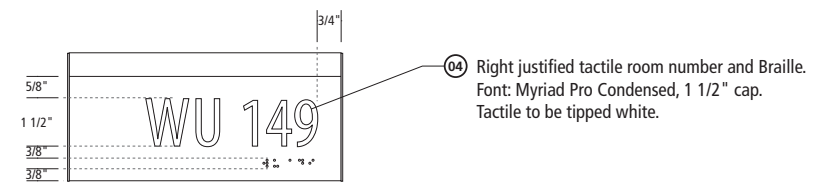

Layout Specifications

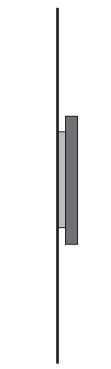

Side View

Exterior Design

I-5
General Room ID

Color

- 01 Gold
- 02 Slate
- 03 Silver Metallic
- 04 White
- 05 Black

Scale

2" = 1' - 0" (on an 11" x 17" sheet)

Notes

This drawing is design-intent only. Fabricator is responsible for fabrication and overall level of quality. Any changes in design, materials, fabrication method or other details must be approved by Corbin Design and PFW.

Client



109 East Front Suite 304
Traverse City, MI 49684
231 947.1236

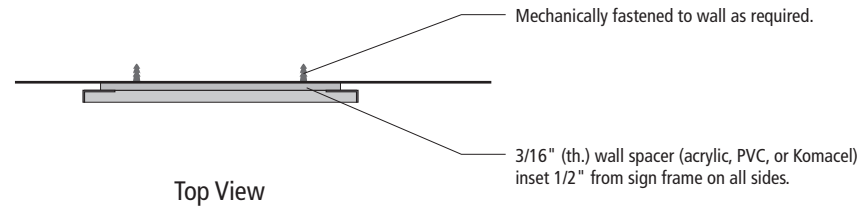

Top View



Side View

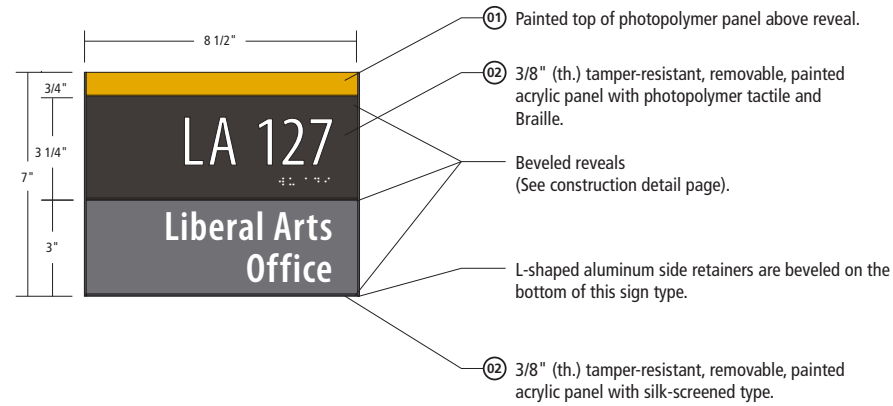

Front View

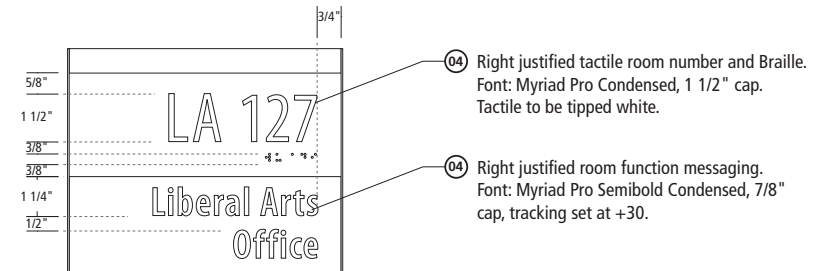

Layout Specifications

Exterior Design

I-5a

General Room ID w/message

Color

- 01 Gold
- 02 Slate
- 03 Silver Metallic
- 04 White
- 05 Black

Scale

2" = 1' - 0" (on an 11" x 17" sheet)

Notes

This drawing is design-intent only. Fabricator is responsible for fabrication and overall level of quality. Any changes in design, materials, fabrication method or other details must be approved by Corbin Design and PFW.

Client

PURDUE
UNIVERSITY
FORT WAYNE

>
corbindesign

109 East Front Suite 304
Traverse City, MI 49684
231 947.1236



Typesetting: Font: Chaparral Pro Semibold, 10" cap, tracking set at +20.



Typesetting: Font: Chaparral Pro Semibold, 10" cap, tracking set at +20.

I-7



Typesetting: Font: Chaparral Pro Semibold, 6" cap, tracking set at +20.



Typesetting: Font: Chaparral Pro Semibold, 6" cap, tracking set at +20.

I-7a



Typesetting: Font: Chaparral Pro Semibold, 4" cap, tracking set at +20.



Typesetting: Font: Chaparral Pro Semibold, 4" cap, tracking set at +20.

I-7b

Typical Construction: 1/4" (th.) painted (Blue) acrylic letters mounted with high bond double-sided tape.

Individual Letters on Light Background





Individual Letters on Dark Background

Exterior Design

I-7, I-7a, I-7b

Individual Letters

Color

- 01  Gold
- 02  Slate
- 03  Silver Metallic
- 04  White
- 05  Black

Scale

1 1/2" = 1' - 0" (on an 11" x 17" sheet)

Notes

This drawing is design-intent only. Fabricator is responsible for fabrication and overall level of quality. Any changes in design, materials, fabrication method or other details must be approved by Corbin Design and PFW.

Client



109 East Front Suite 304
Traverse City, MI 49684
231 947.1236

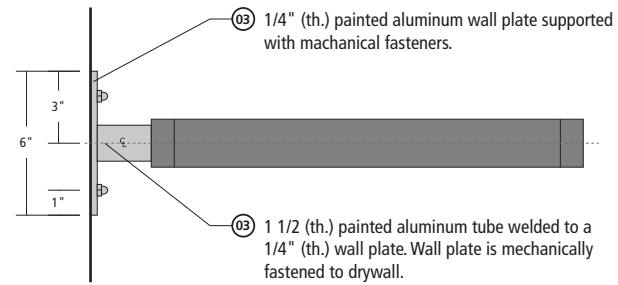

Top View

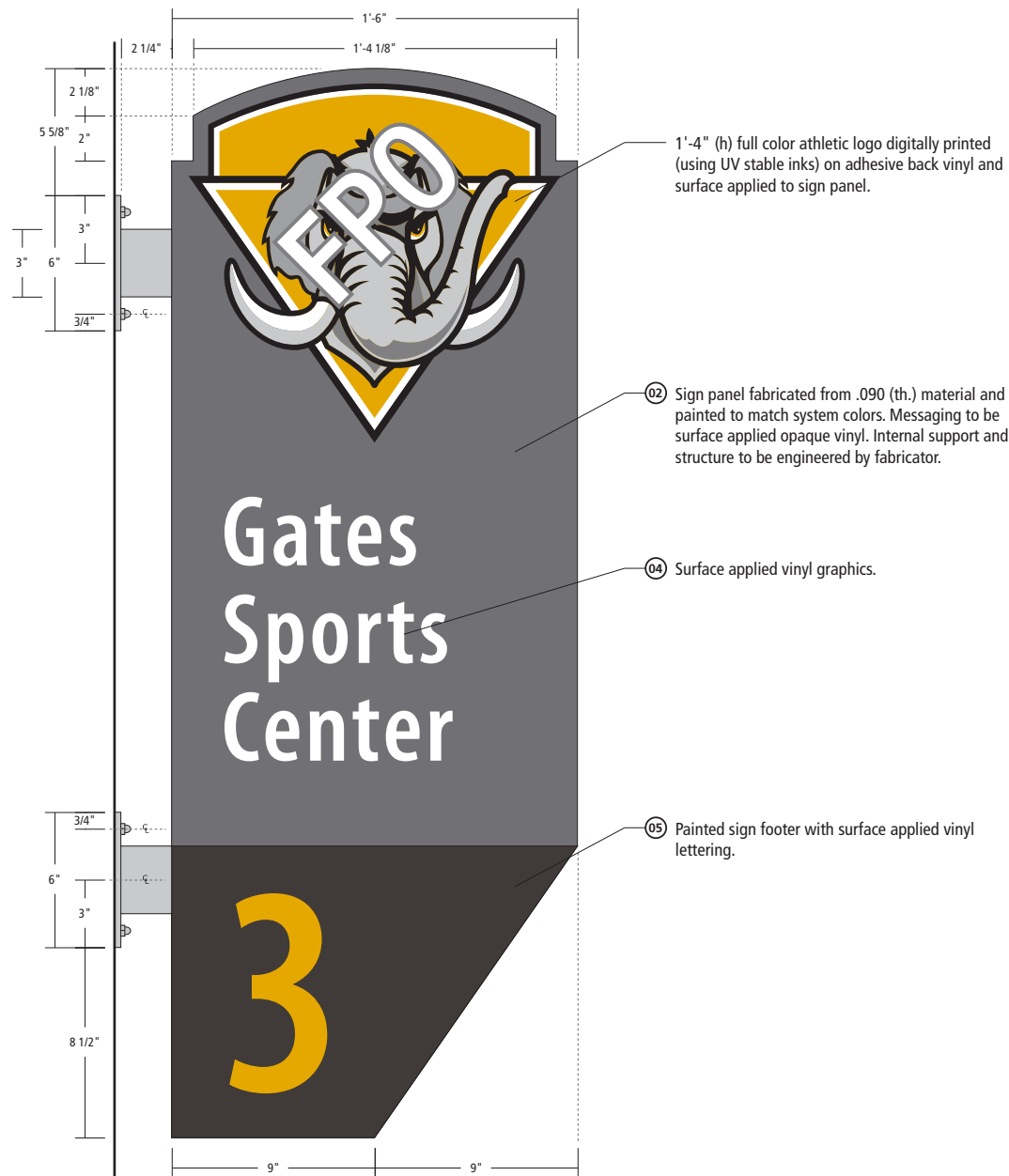

Front View

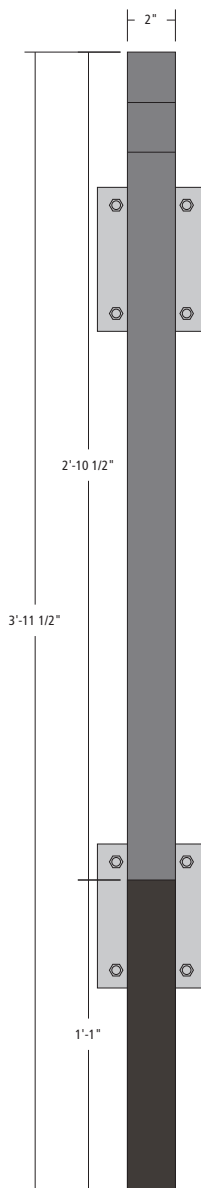

Side View

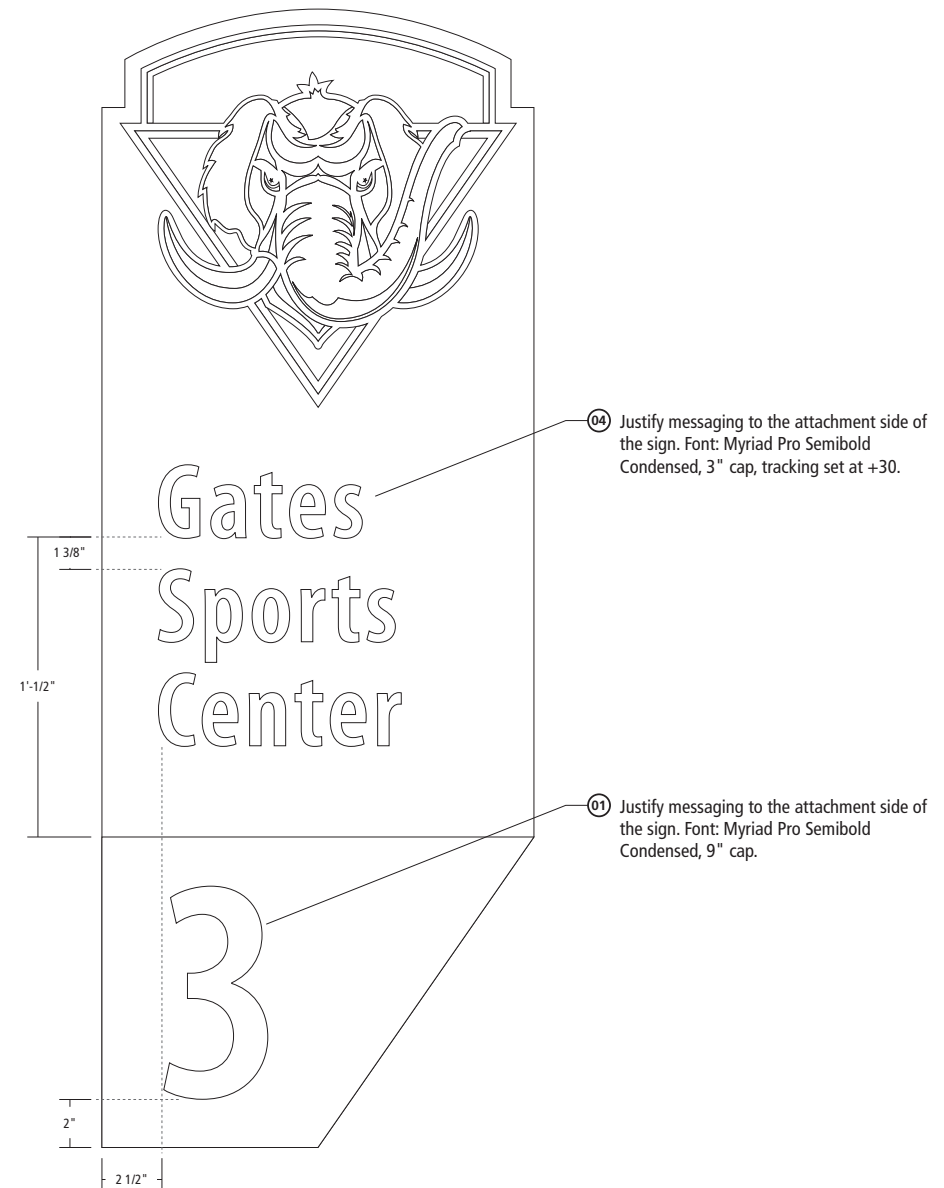

Layout Specifications

Exterior Design

O-1
Overhead Flag – Custom

Color

- ① Gold
- ② Slate
- ③ Silver Metallic
- ④ White
- ⑤ Black

Scale

1 1/2" = 1' - 0" (on an 11" x 17" sheet)

Notes

This drawing is design-intent only. Fabricator is responsible for fabrication and overall level of quality. Any changes in design, materials, fabrication method or other details must be approved by Corbin Design and PFW.

Client

PURDUE
UNIVERSITY
FORT WAYNE

corbindesign

109 East Front Suite 304
Traverse City, MI 49684
231 947.1236

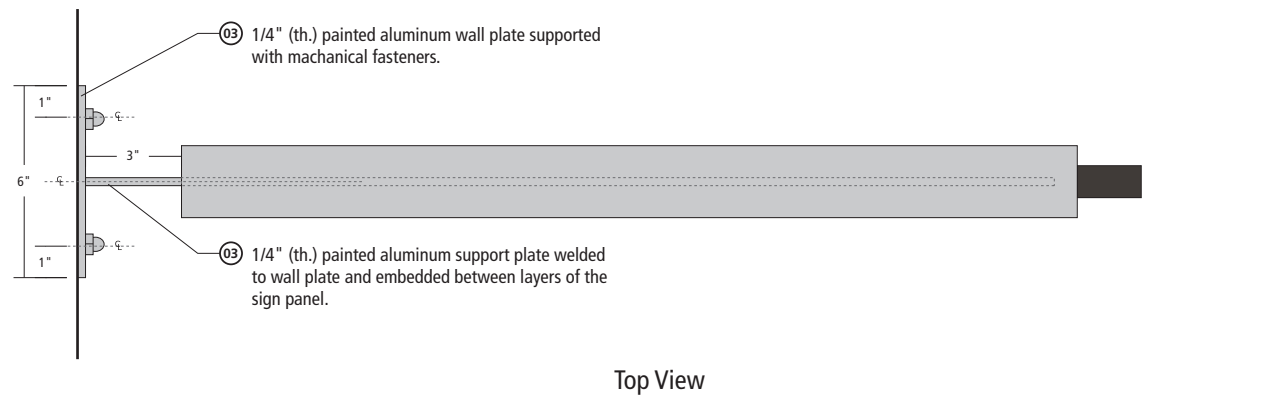

Top View

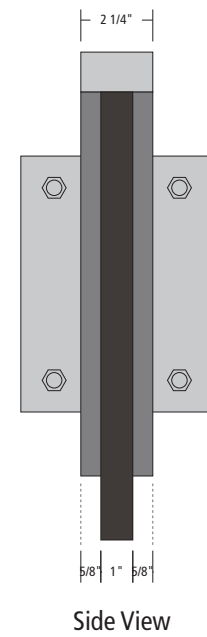

Side View

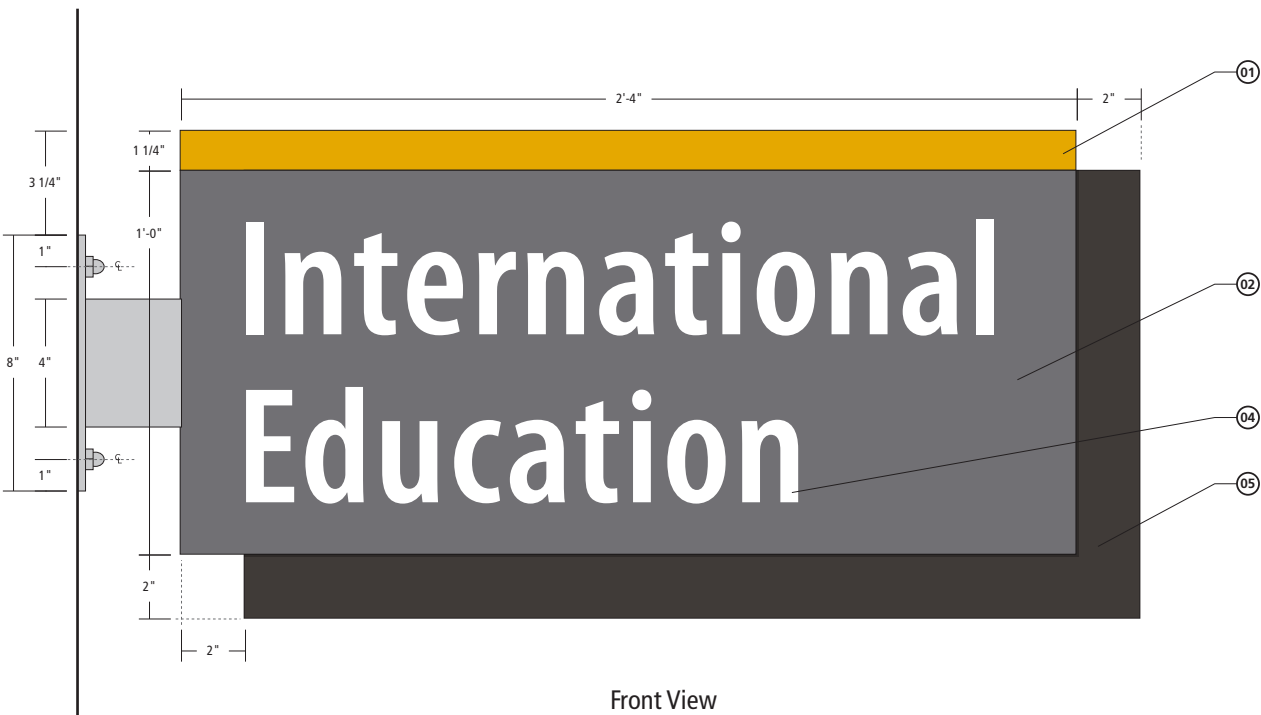

Front View

05 Sign panel is constructed from layers of painted Komacel surrounding a structural aluminum support plate.

Center in space
Font: Myriad Pro Semibold Condensed,
2 3/4" cap
tracking set at +20.



Alternate Layouts

Exterior Design

O-2

Overhead Flag – Large

Color

- 01 Gold
- 02 Slate
- 03 Silver Metallic
- 04 White
- 05 Black

Scale

2" = 1' - 0" (on an 11" x 17" sheet)

Notes

This drawing is design-intent only. Fabricator is responsible for fabrication and overall level of quality. Any changes in design, materials, fabrication method or other details must be approved by Corbin Design and PFW.

Client

PURDUE
UNIVERSITY
FORT WAYNE

>
corbindesign

109 East Front Suite 304
Traverse City, MI 49684
231 947.1236



04 Justify messaging to the attachment side of the sign and center vertically within gray field on the sign panel. Font: Myriad Pro Semibold Condensed, 3 1/2" cap, tracking set at +20.

Layout Specifications

O-3
Overhead Flag – Small

Color

- 01 Gold
- 02 Slate
- 03 Silver Metallic
- 04 White
- 05 Black

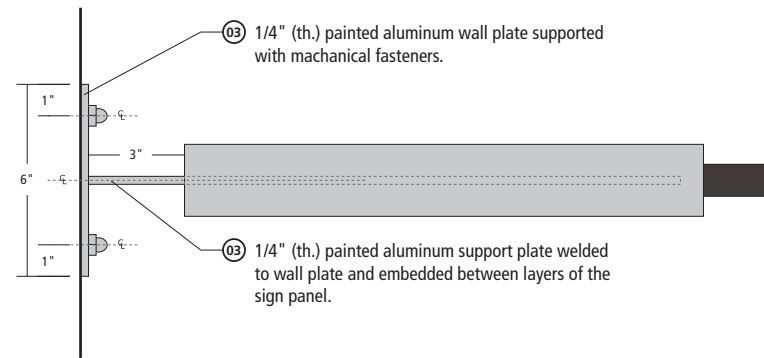

Top View

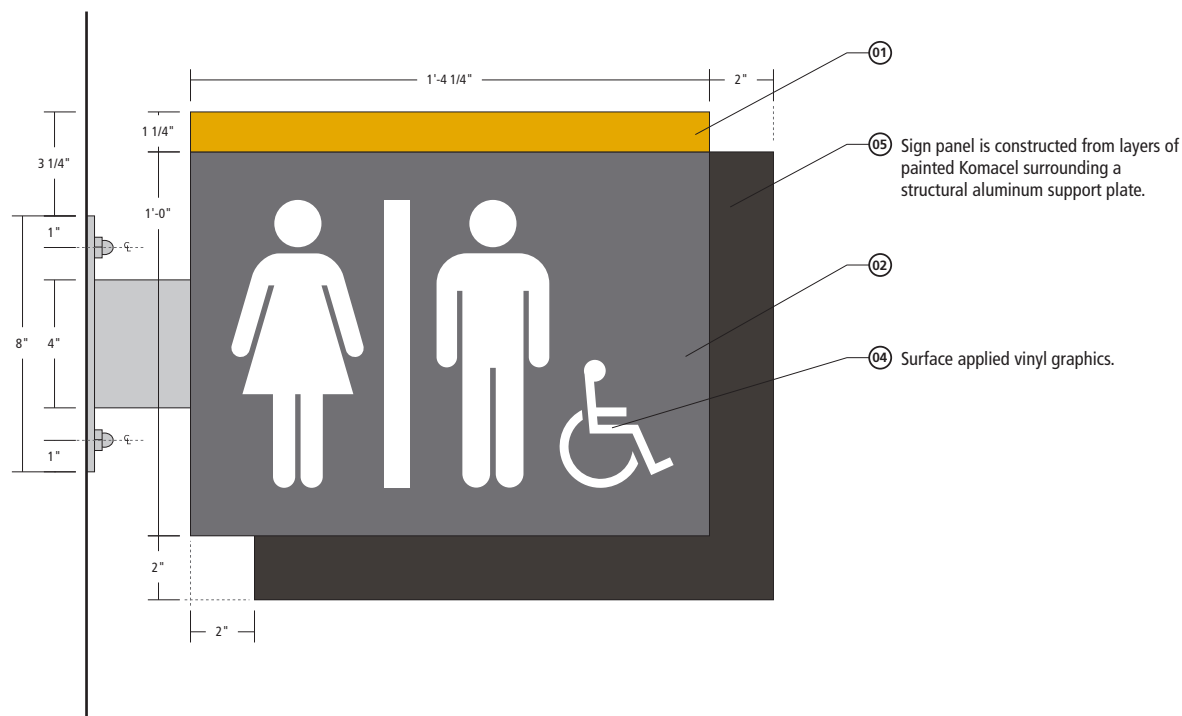

Front View

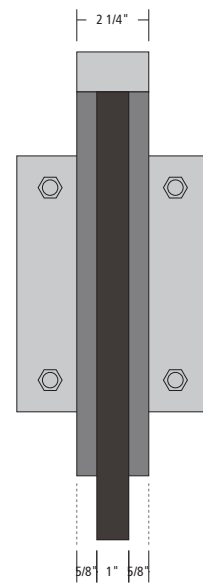

Side View

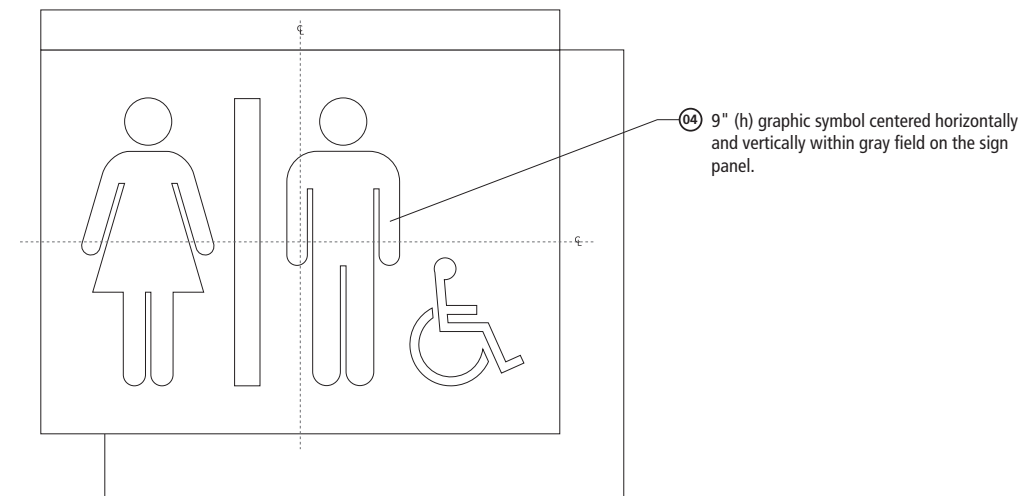

Layout Specifications

Scale

2" = 1' - 0" (on an 11" x 17" sheet)

Notes

This drawing is design-intent only. Fabricator is responsible for fabrication and overall level of quality. Any changes in design, materials, fabrication method or other details must be approved by Corbin Design and PFW.

Client

PURDUE
UNIVERSITY
FORT WAYNE

>
corbindesign

109 East Front Suite 304
Traverse City, MI 49684
231 947.1236

O-4
Overhead Guide

Color

- ① Gold
- ② Slate
- ③ Silver Metallic
- ④ White
- ⑤ Black

Scale

2" = 1' - 0" (on an 11" x 17" sheet)

Notes

This drawing is design-intent only. Fabricator is responsible for fabrication and overall level of quality. Any changes in design, materials, fabrication method or other details must be approved by Corbin Design and PFW.

Client



109 East Front Suite 304
Traverse City, MI 49684
231 947.1236

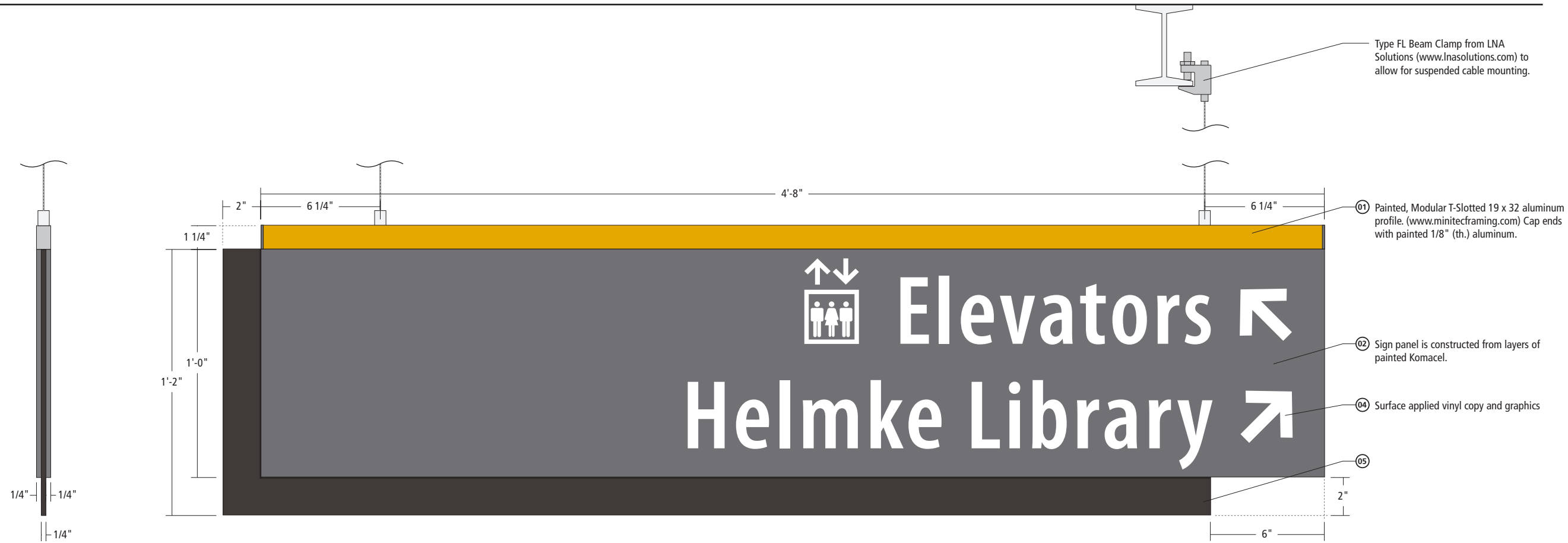

Front View

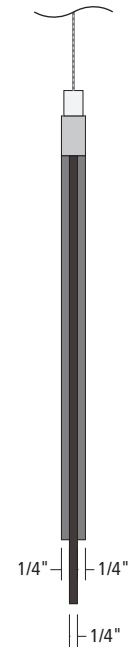

Side View

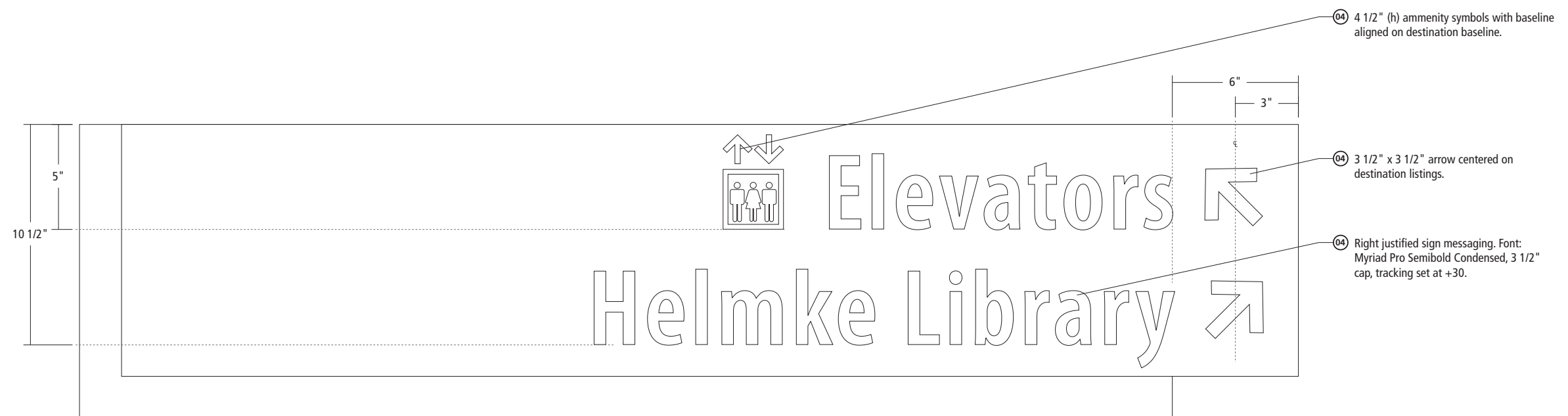

Layout Specifications

O-5

Overhead ID

Color

- ① Gold
- ② Slate
- ③ Silver Metallic
- ④ White
- ⑤ Black

Scale

2" = 1' - 0" (on an 11" x 17" sheet)

Notes

This drawing is design-intent only. Fabricator is responsible for fabrication and overall level of quality. Any changes in design, materials, fabrication method or other details must be approved by Corbin Design and PFW.

Client

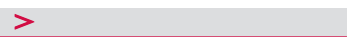

corbindesign

109 East Front Suite 304
Traverse City, MI 49684
231 947.1236



Front View

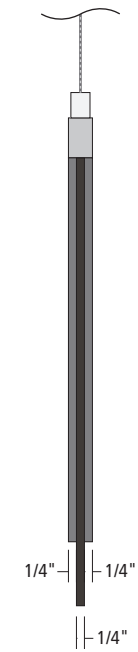

Side View



Layout Specifications

Exterior Design

O-6
Overhead Flag, Insert-based
Wall Mounted

Color

- 01 Gold
- 02 Slate
- 03 Silver Metallic
- 04 White
- 05 Black

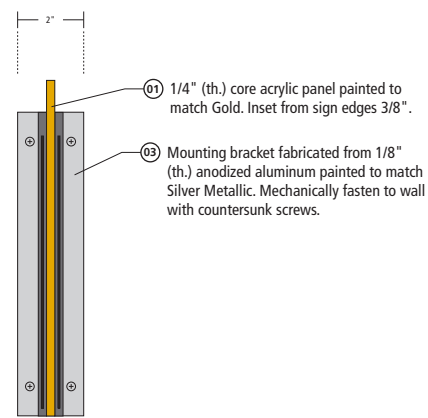

Side View

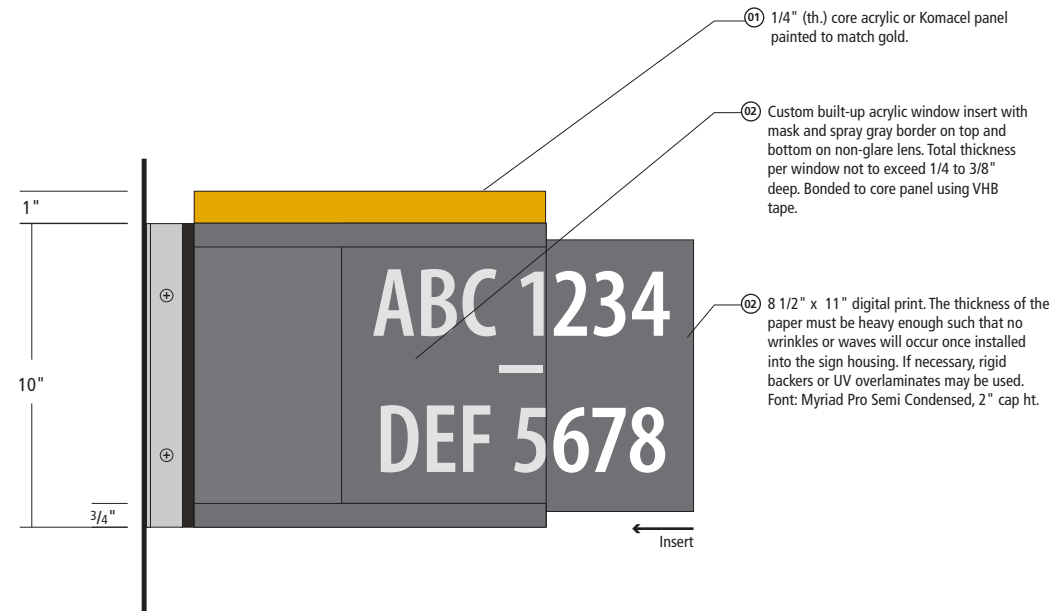

Front View

Scale

2" = 1' - 0" (on an 11" x 17" sheet)

Notes

This drawing is design-intent only. Fabricator is responsible for fabrication and overall level of quality. Any changes in design, materials, fabrication method or other details must be approved by Corbin Design and PFW.

Client



109 East Front Suite 304
Traverse City, MI 49684
231 947.1236

R-1
Regulatory

Color

- 01 Gold
- 02 Slate
- 03 Silver Metallic
- 04 White
- 05 Black

Scale

2" = 1' - 0" (on an 11" x 17" sheet)

Notes

This drawing is design-intent only. Fabricator is responsible for fabrication and overall level of quality. Any changes in design, materials, fabrication method or other details must be approved by Corbin Design and PFW.

Client

PURDUE
UNIVERSITY
FORT WAYNE

>
corbindesign

109 East Front Suite 304
Traverse City, MI 49684
231 947.1236

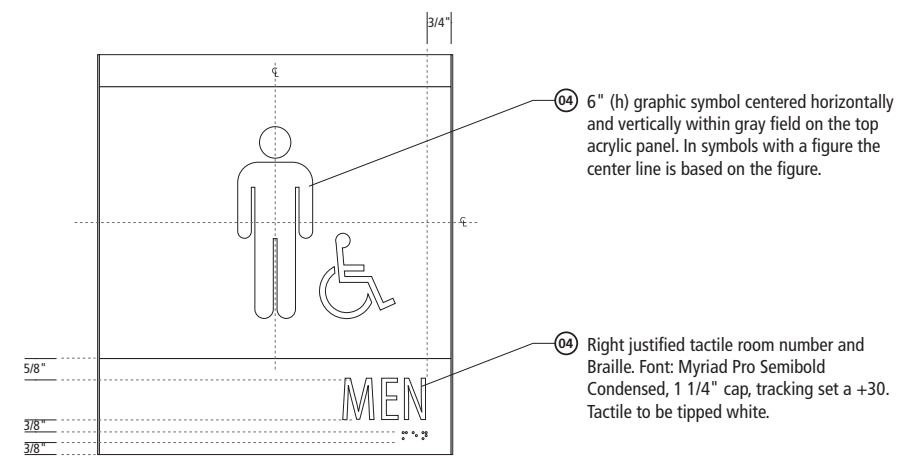
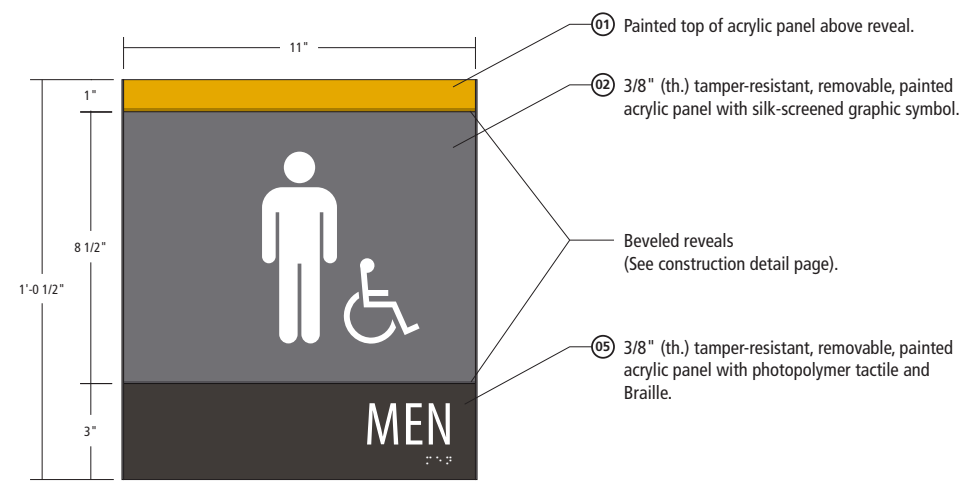
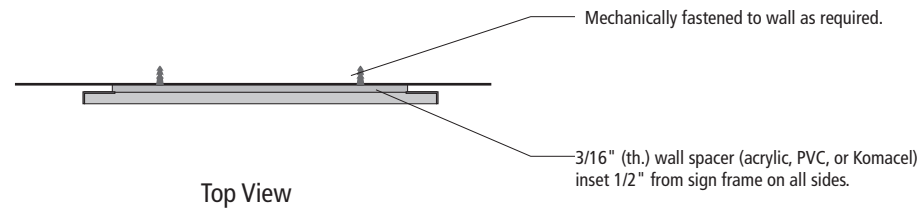

Layout Specifications

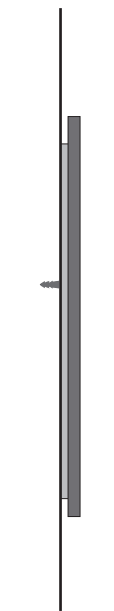

Front View

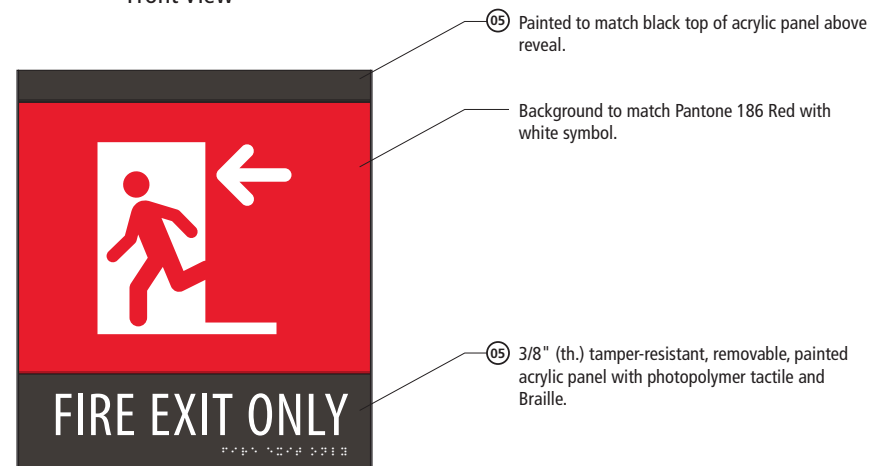

Alternate Layout

